



Hrvatska turistička zajednica



CROATIA

**CROATIAN CONVENTION
AND INCENTIVE BUREAU**

Tehničke karakteristike štanda

Konstrukcija i svi ugradbeni materijali i oprema moraju imati sve potrebne standarde kvalitete, kao i sigurnosne i požarne ateste.

Pod je povišen visine 1,8 cm (iverica ili iveral). Na ivericu se polaže tepih crvene boje.

Štand Hrvatskog kongresnog i insentiv ureda (HKIU) Hrvatske turističke zajednice na kongresnim sajmovima je podjeljen na:

- dio za prezentaciju HKIU-a
- dio za predavanja
- dio za suizlagače
- dio zajedničkog prostora - skladište

Na dijelu štanda za prezentaciju HKIU-a su garniture za sjedenje -stolovi sa 4 stolca, pultevi od bijelog iverala sa prosvijetljenim pleksijem, 4 barska stola i 4 kom plazme 42" sa samostojećim kromiranim stalkom za plazmu i DVD-om.

Dio za predavanja sa 20 stolaca.

Dijelovi štanda za suizlagače su površine 4, 8 ili 10 m².

Na suizlagačkom dijelu štandu od 4 m² nalazi se slijedeća oprema:

stol, stolac kom 4, zastavica na stolu sa logotipom i pleksiglas stalkom sa qr codom, stalak za prospekte i koš za smeće.

Na suizlagačkom dijelu štandu od 8 m² nalazi se slijedeća oprema: stol kom 2, stolac kom 6, ormarić 100/50 v=80 cm s ključem, zastavica s logotipom na stolu i pleksiglas stalkom sa qr codom, stalak za prospekte, koš za smeće, ograda od aluminijske konstrukcije "isogon", stup visine 150 cm sa nogicom i metalnim spojnicama za učvršćivanje pleksi ispuna.

Na suizlagačkom dijelu štandu od 10 m² nalazi se slijedeća oprema: stol kom 2, stolac kom 6, zastavica s logotipom na stolu i pleksiglas stalkom sa qr codom, barski stolac, koš za smeće, ograda od aluminijske konstrukcije "isogon", stup visine 150 cm sa nogicom i metalnim spojnicama za učvršćivanje pleksi ispuna i info pult od bijelog iverala sa prosvijetljenim pleksijem sa barskim stolcem.

Na zajedničkom prostoru štanda je skladište od isogon konstrukcije sa harmo vratima, stijenama od bijelog dupleksa ili bijelog forexa i bijelog pleksiglasa debljine 3 - 4 mm. U skladištu su police na tri etaže, dimenzija 100/50 cm, vješalica, koš za smeće i hladnjak.

Na sajmovima gdje je omogućeno vješanja sa stropne konstrukcije se postavlja aluminijska rešetkasta konstrukcija promjera 5m sa obostrano ceradom i motivom HTZ-a visine 200cm. Rešetkasta konstrukcija promjera 5m se vjesa na visinu 800cm.

Na visini od 500cm se vjesa ovalna restkasta konstrukcija dimenzija 9x5m sa obostrano printaom ceradom sa motivima HTZ-a, visine 150cm.

Konstrukcija se vješa sa čeličnim sajlama za strop hale prema projektu i odobrenju organizatora sajma.

Zidovi skladišta ravni - dimenzija 43,5 x 242 cm, 93 x 242 cm i 1/4 kruga Ø 200 - luk dužine 149 x 242 cm se oslikavaju kongresnim i turističkim motivima sa PVC samoljepivim folijama koje se usaglašavaju s Uredom HTZ-a za svaki sajam a prema knjizi aplikacija (CD-i sa grafičkim pripremama motiva) koju će HTZ dostaviti svim izvođačima.

Ukoliko su štandovi locirani uz zidove hale ili nekim dijelom štanda imaju zid sa susjednim štandom, mora se izraditi zid štanda od isogon ili oktanorm konstrukcije.

Vidljivi zidovi moraju biti oslikani kongresnim i turističkim motivima sa PVC samoljepivim folijama koje se usaglašavaju s Uredom HTZ-a za svaki sajam a prema knjizi aplikacija (CD-i sa grafičkim pripremama motiva) koju će HTZ dostaviti svim izvođačima..

Cvijetni aranžmani - visine cca 120 - 150 cm - u lončanicama za štandove do 50 m² - kom 2, od 50 - 100 m² - kom 4, od 100 - 200 m² - kom 6 - 8.

Elektroinstalacija štanda se radi prema elektroplanu štanda. Na štandu je elektroormar, utičnice, fluo rasvjeta skladišta, metalhalogeni reflektori 150 - 300 w za osvjetljavanje slika na zidovima skladišta, za led ekrane potrebno je osigurati 2 x 63A (80 kw), za vrijeme trajanja montaže, i demontaže štanda, te za vrijeme trajanja sajma neprekidno napajanje strujom 0-24h.

Primjer štanda 200-300²

3 Tlocrt štanda

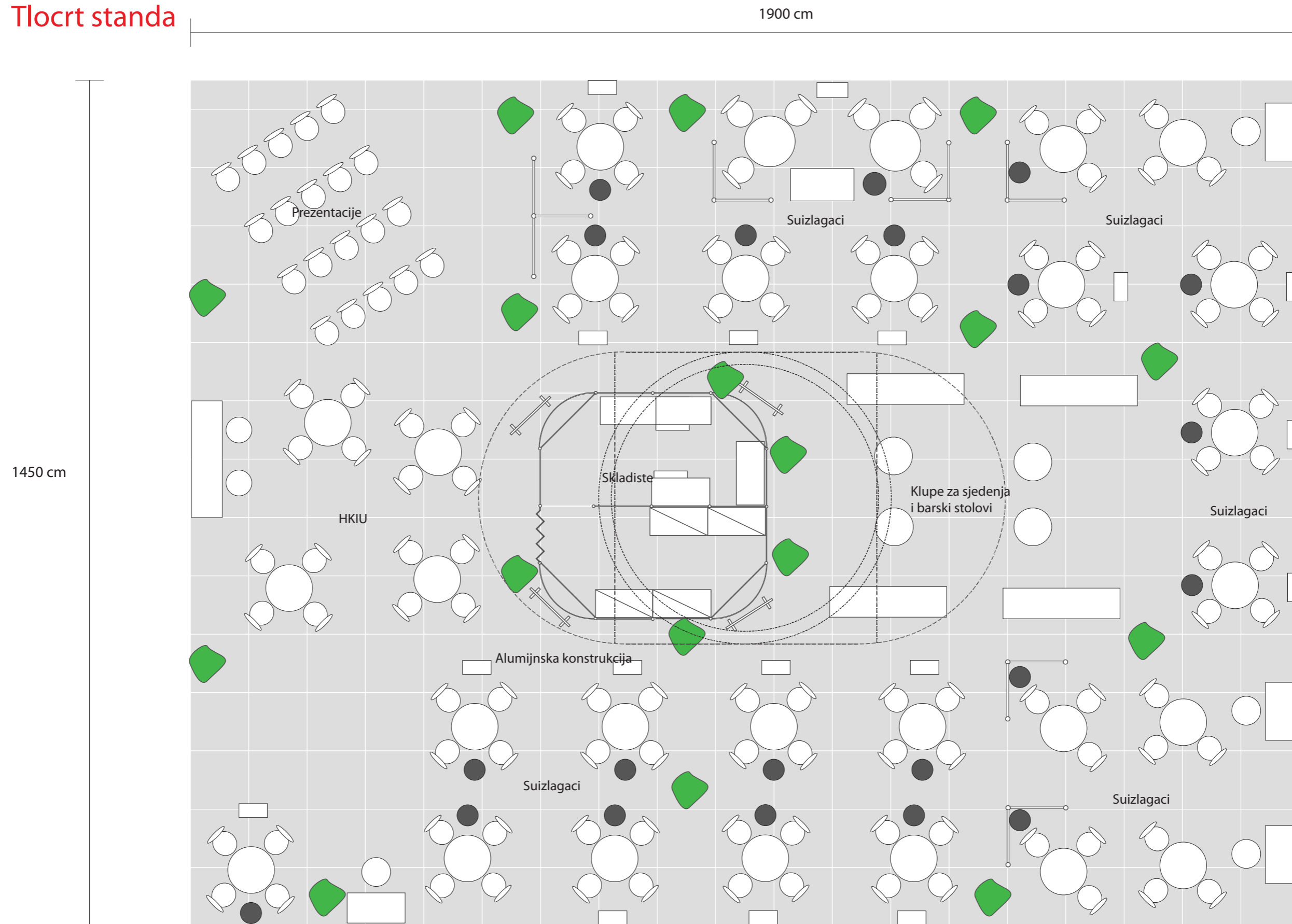

Primjer štanda 250-300²

4 3d vizualizacija





Primjer štanda 250-300²

5 3d vizualizacija



6 Elektroplan

-  Uricnica
-  Elektroromar
-  Metalhalogeni reflektor

1450 cm

1900 cm

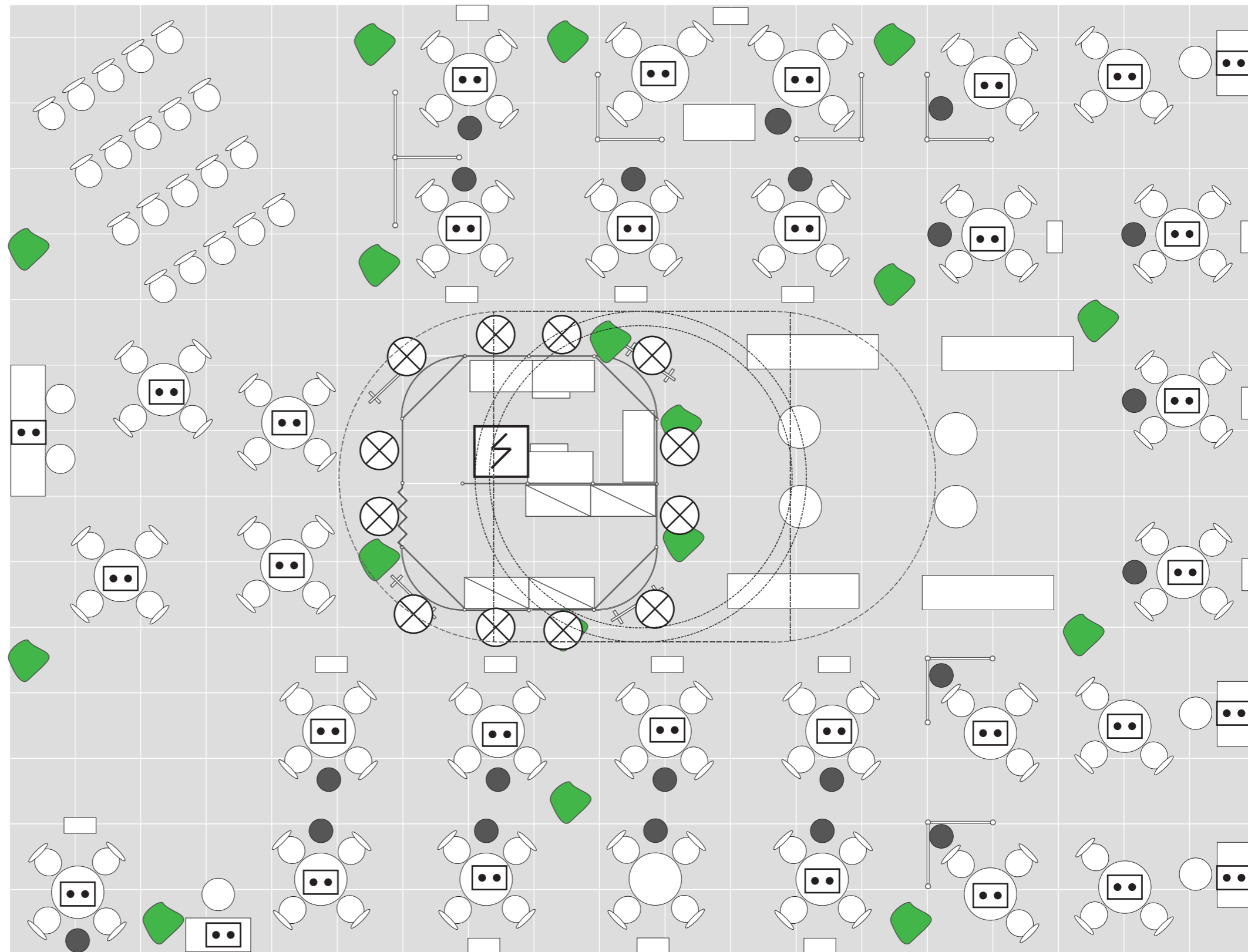

Primjer štanda 250-300²

7 Pogled

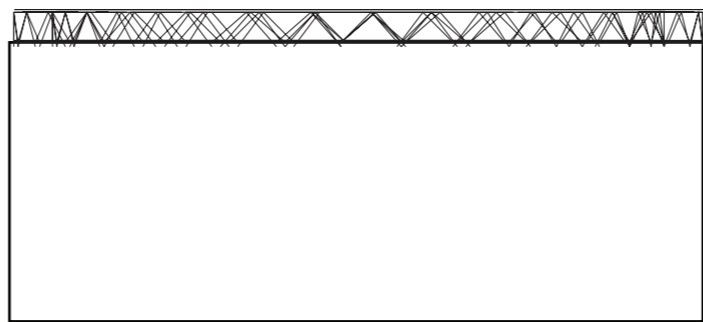

200 cm

100 cm

150 cm

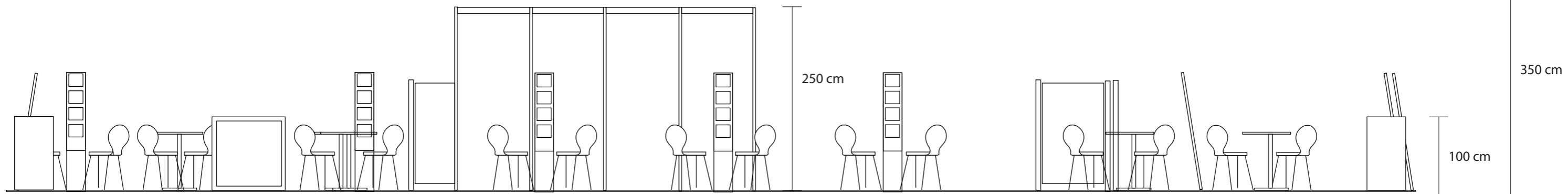

Primjer štanda 250-300²

8 Raspored suizlagača

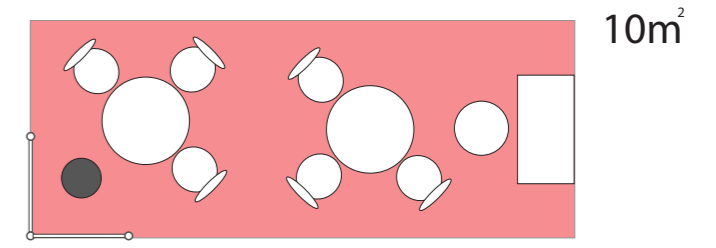
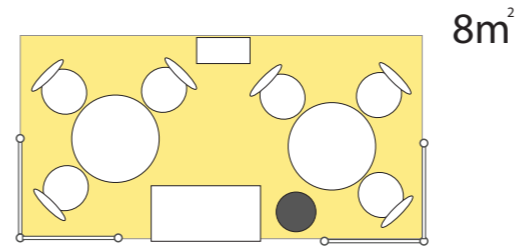
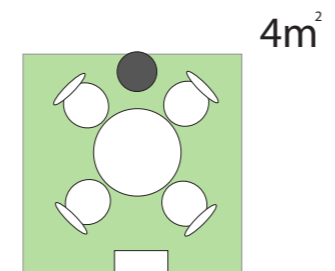
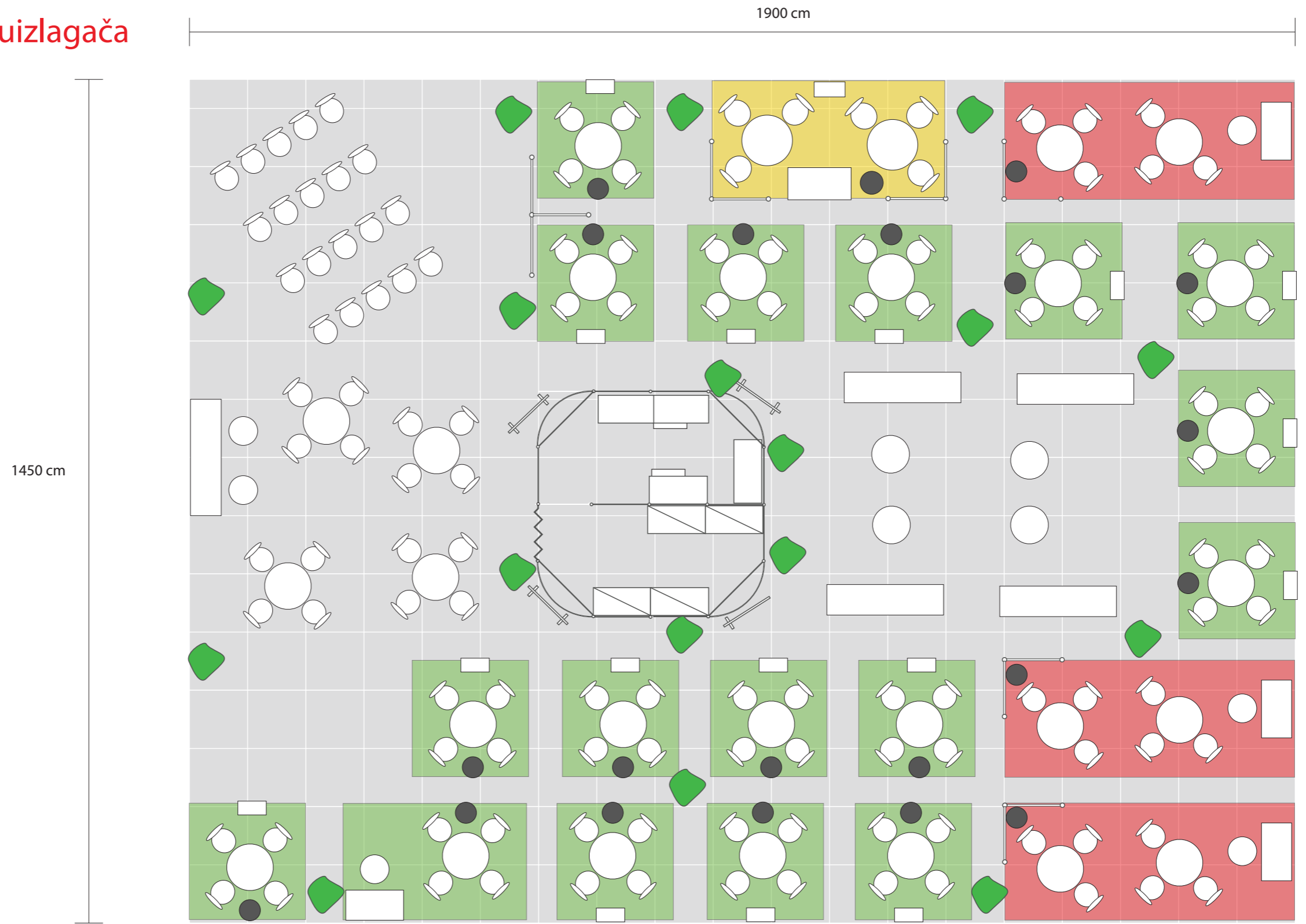

Primjer štanda 150-250²

9 Tlocrt štanda

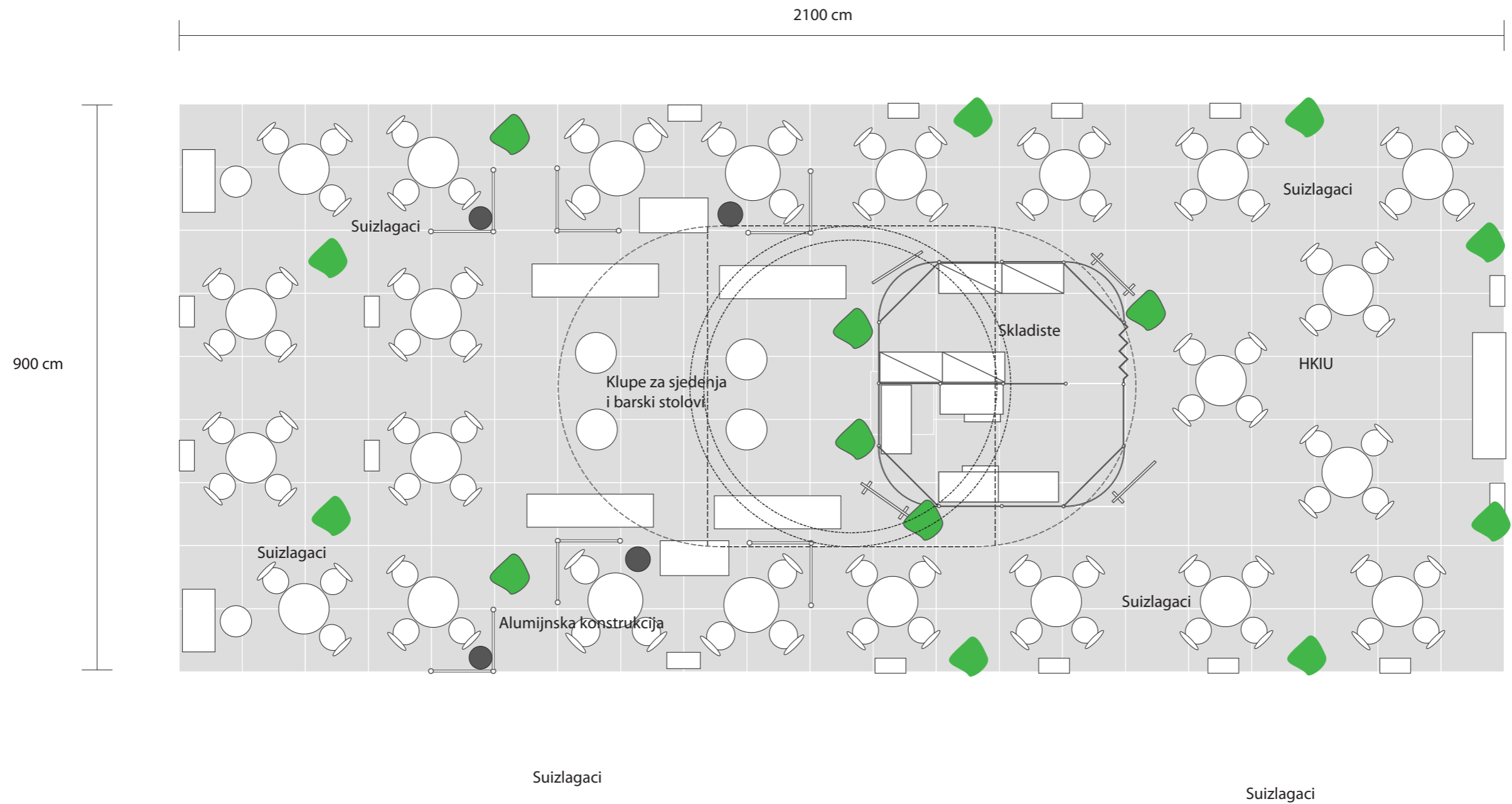

Primjer štanda 150-250²

10 3d vizualizacija

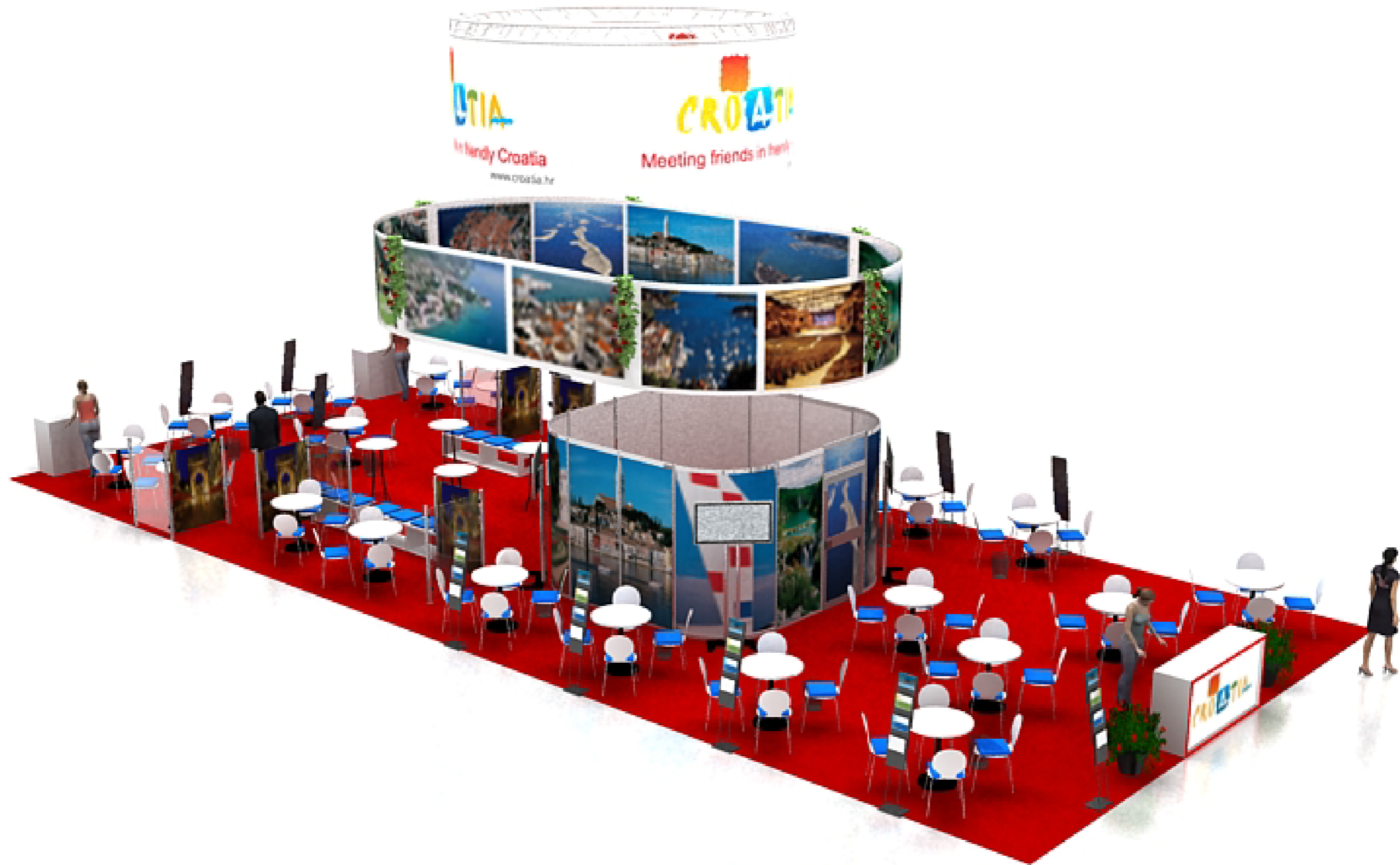

Primjer štanda 150-250²

11 3d vizualizacija



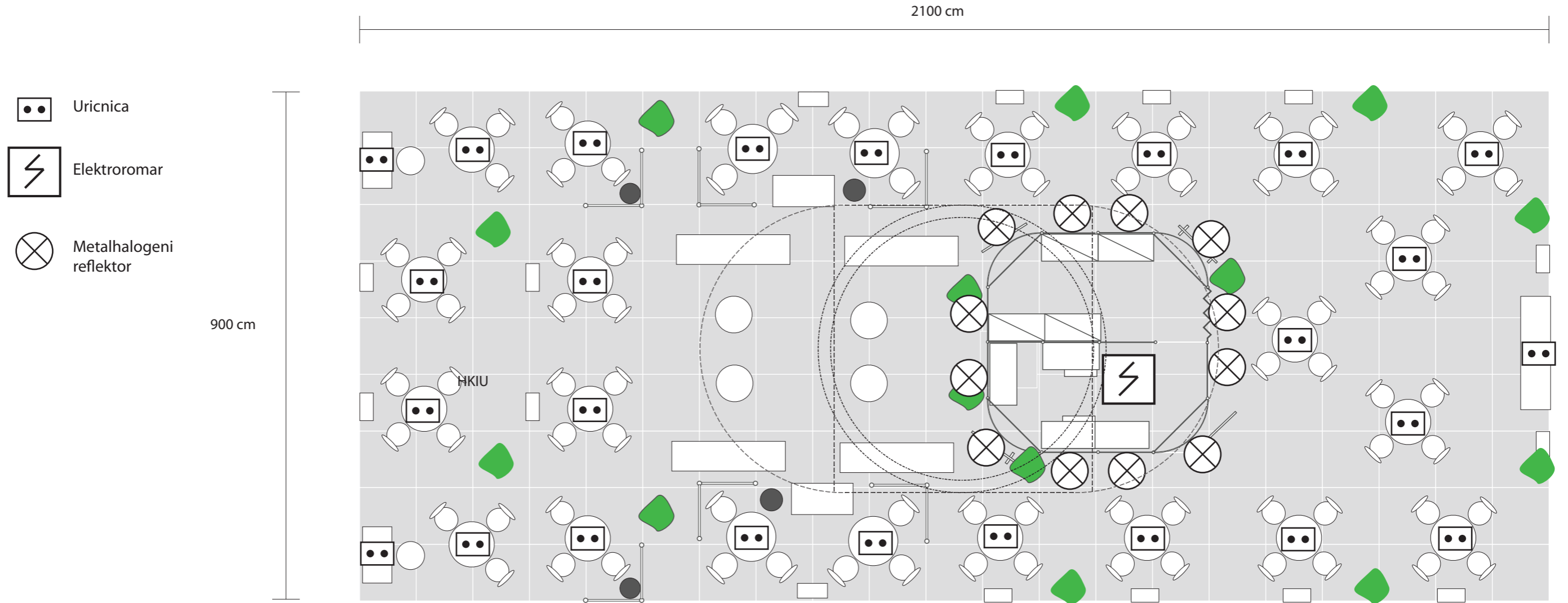

Primjer štanda 150-250²

13 Pogled

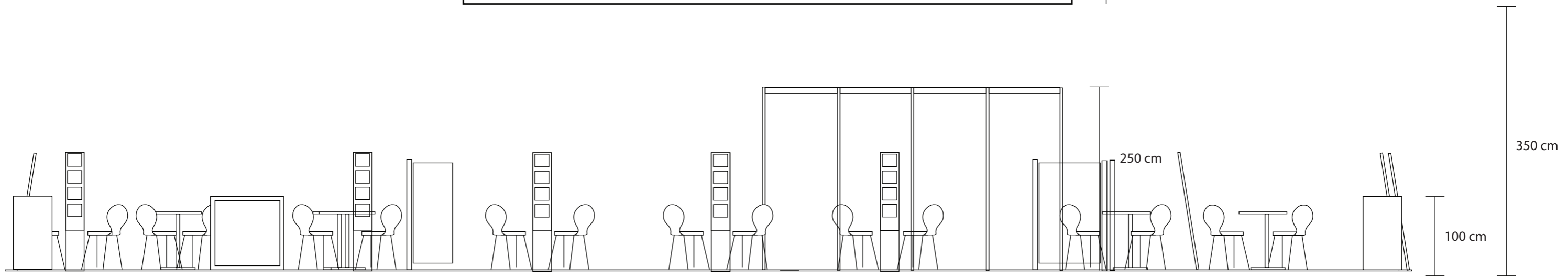
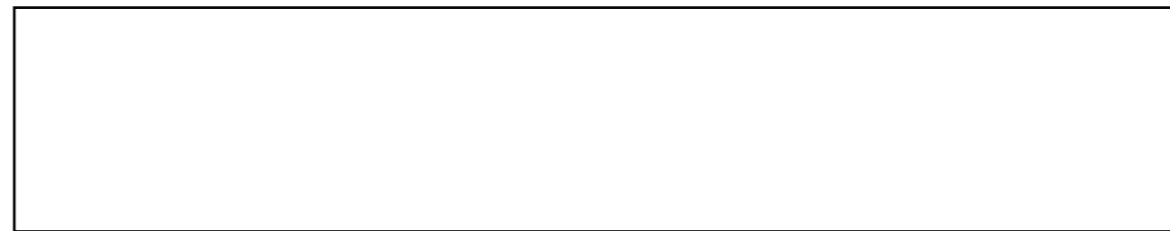
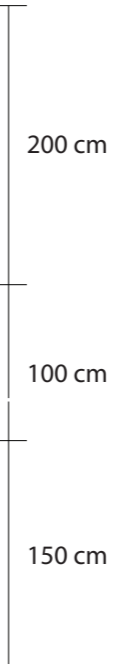
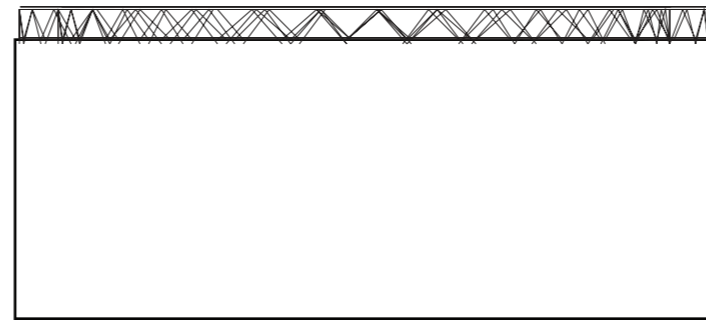

Primjer štanda 150-250²

14 Raspored suizlagača

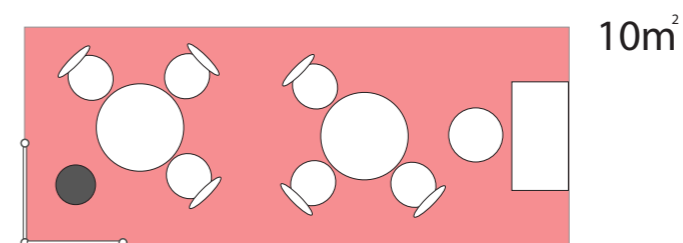
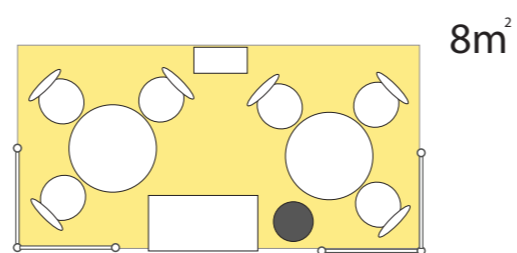
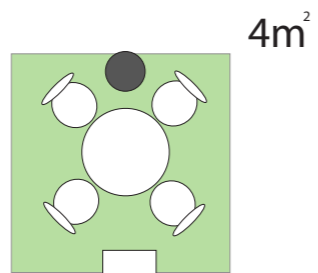
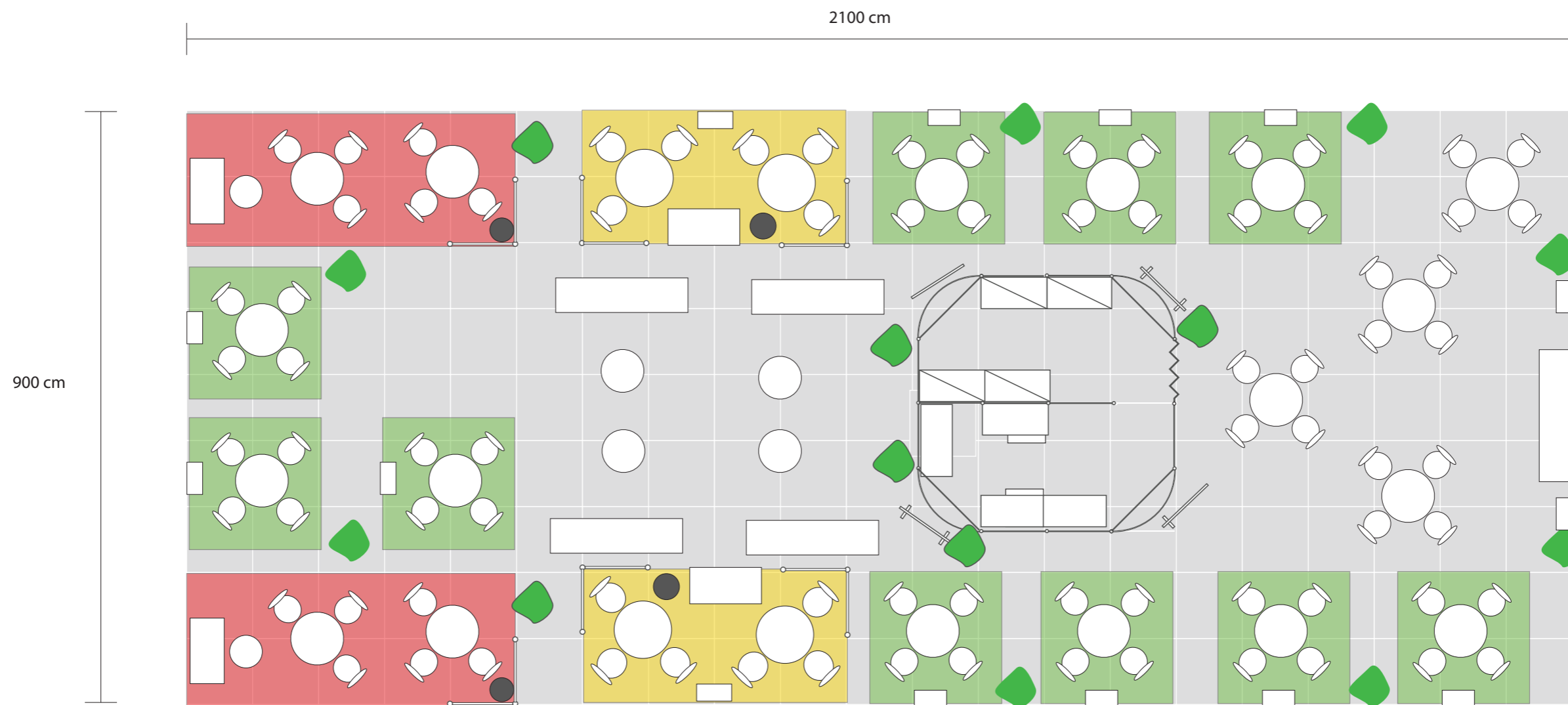

Primjer štanda 75-150²

15 Tlocrt

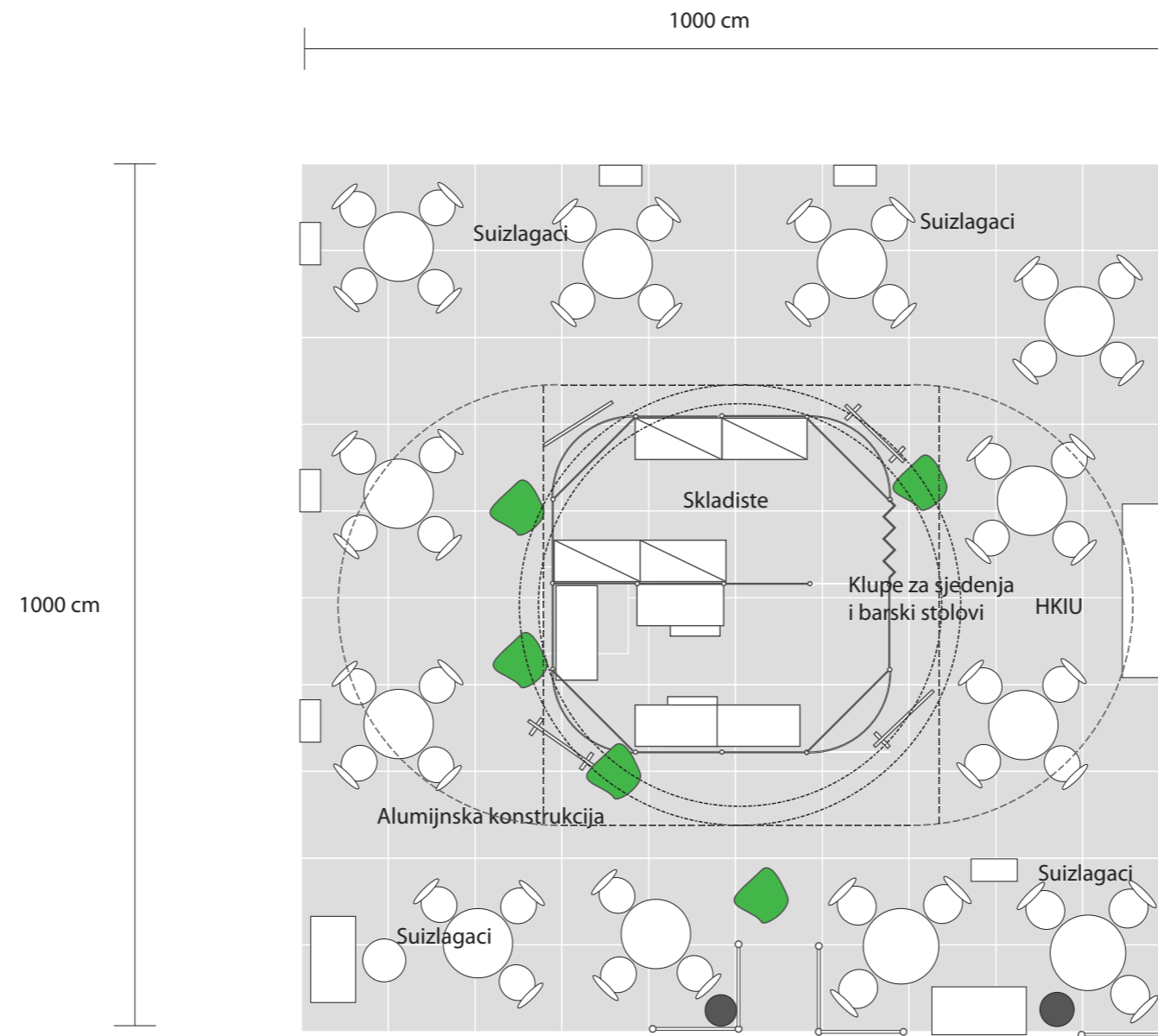

Primjer štanda 75-150²



16 3d vizualizacija



Primjer štanda 75-150²

17 3d vizualizacija



-  Uricnica
-  Elektroromar
-  Metalhalogeni reflektor

1000 cm

1000 cm

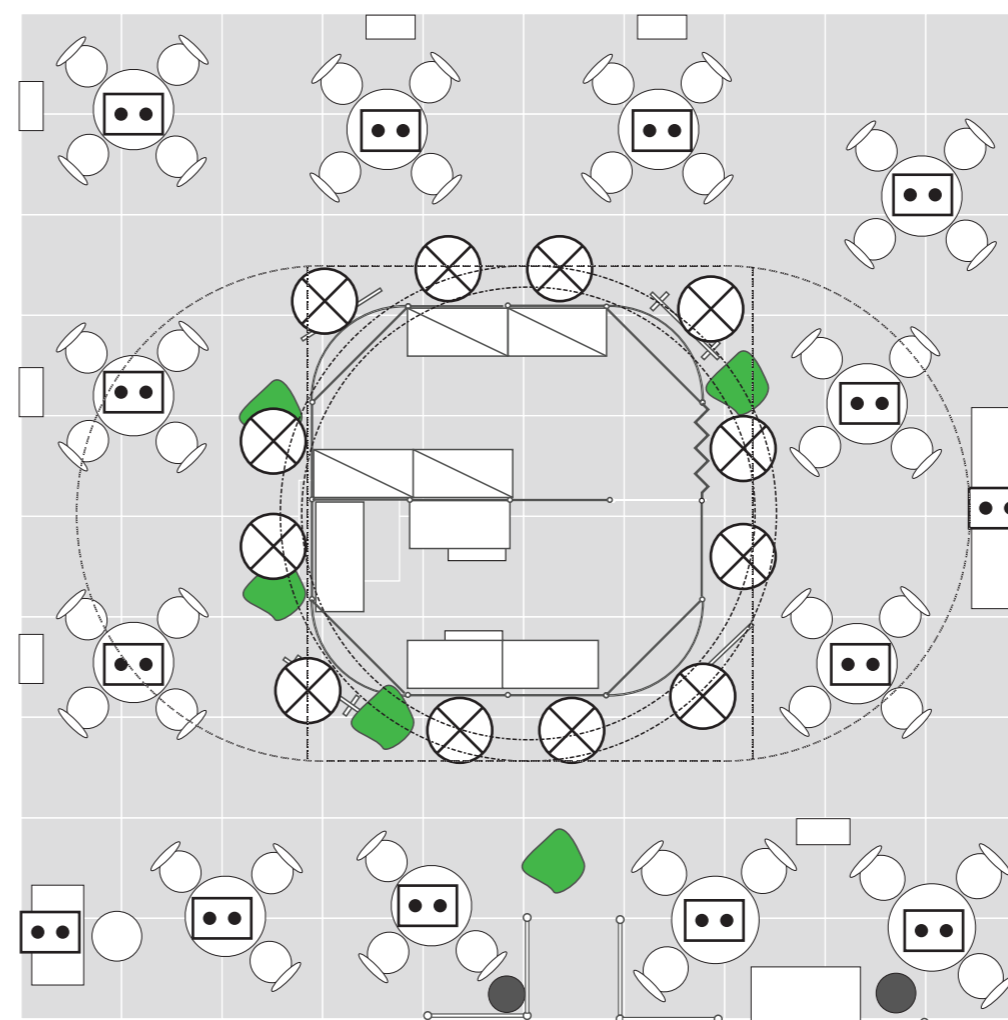

Primjer štanda 75-150²

19 Pogled

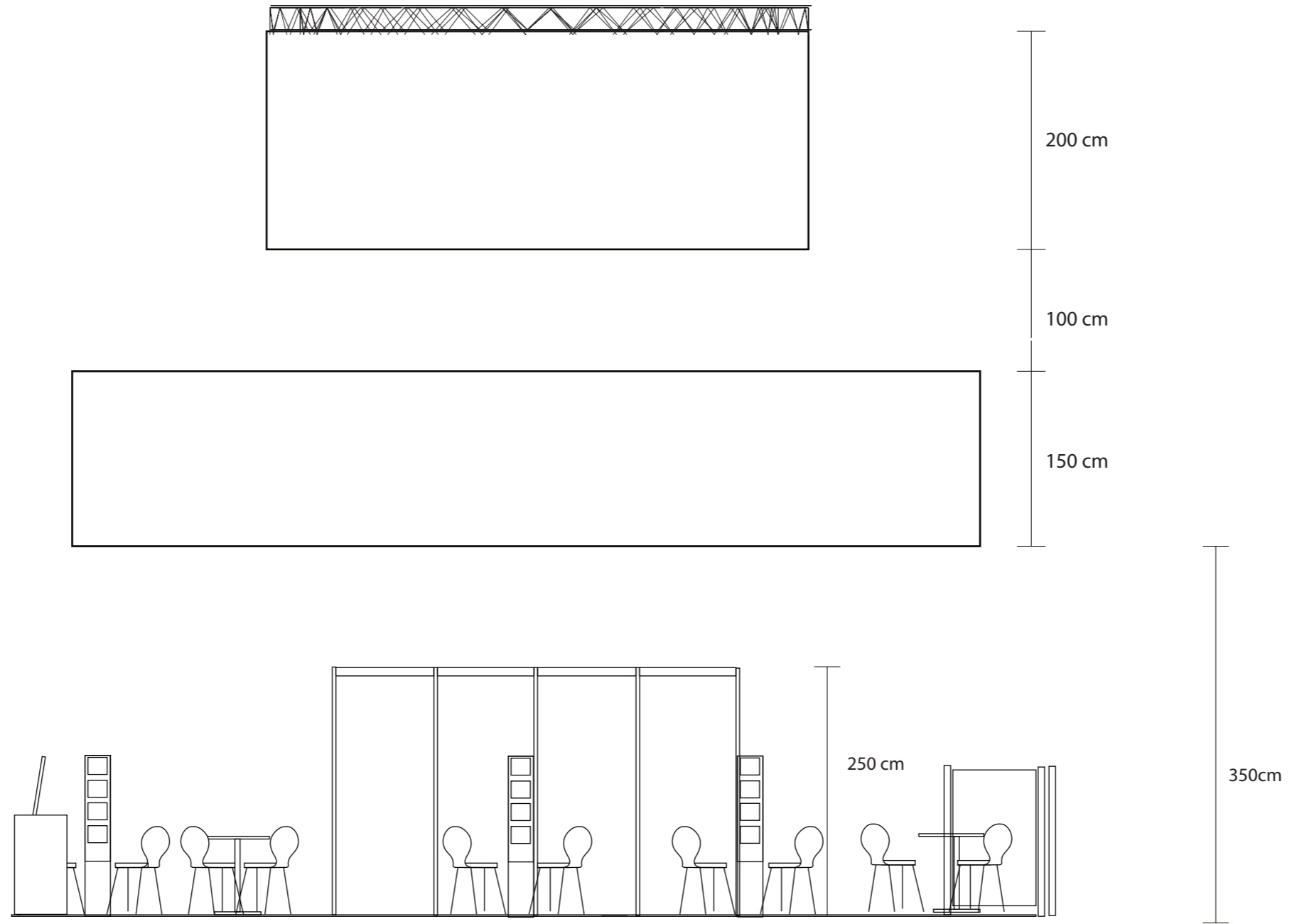

Primjer štanda 75-150²

20 3d vizualizacija

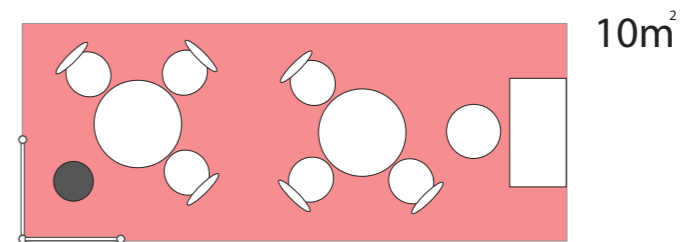
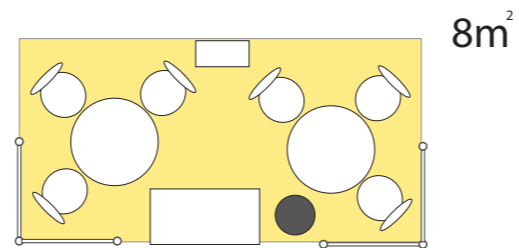
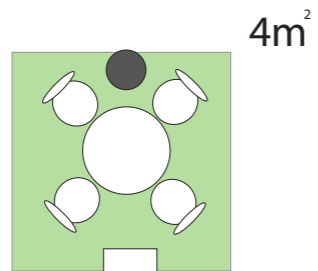

21

Suizlagački prostor 4m²

1. Stol sa stolicima:
stol o 80cm, bijela okrugla ploča
stolac tipa "Flower", bijeli, plavi jastučići
zastavica od foreksa sa logotipom suizlagaca
QR code na stalku od bijelog opal pleksiglasa
2. Stalak za prospekte
3. Koš za smeće
4. certificirani protupožarni tepih crvene boje

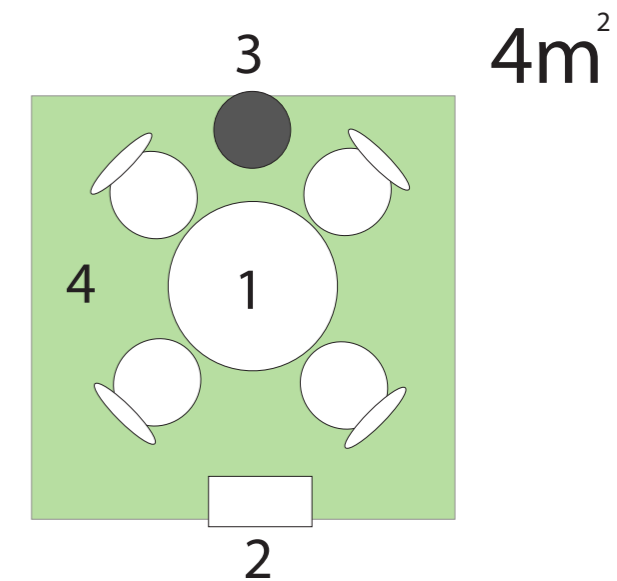

22

Suizlagački prostor 8 m²

1. Stol sa stolicima:

stol o 80cm, bijela okrugla ploča
stolac tipa "Flower", bijeli, plavi jastučići
zastavica od foreksa sa logotipom suizlagaca
QR code na stalku od bijelog opal pleksiglasa

2. Stalac za prospekte

3. Koš za smeće

4. certificirani protupožarni tepih crvene boje

5. Ormaric od bijelog iverala sa ključem

6 Pregradice:

alumijski stupovi sa prozirnim pleksiglasom ili grafikom

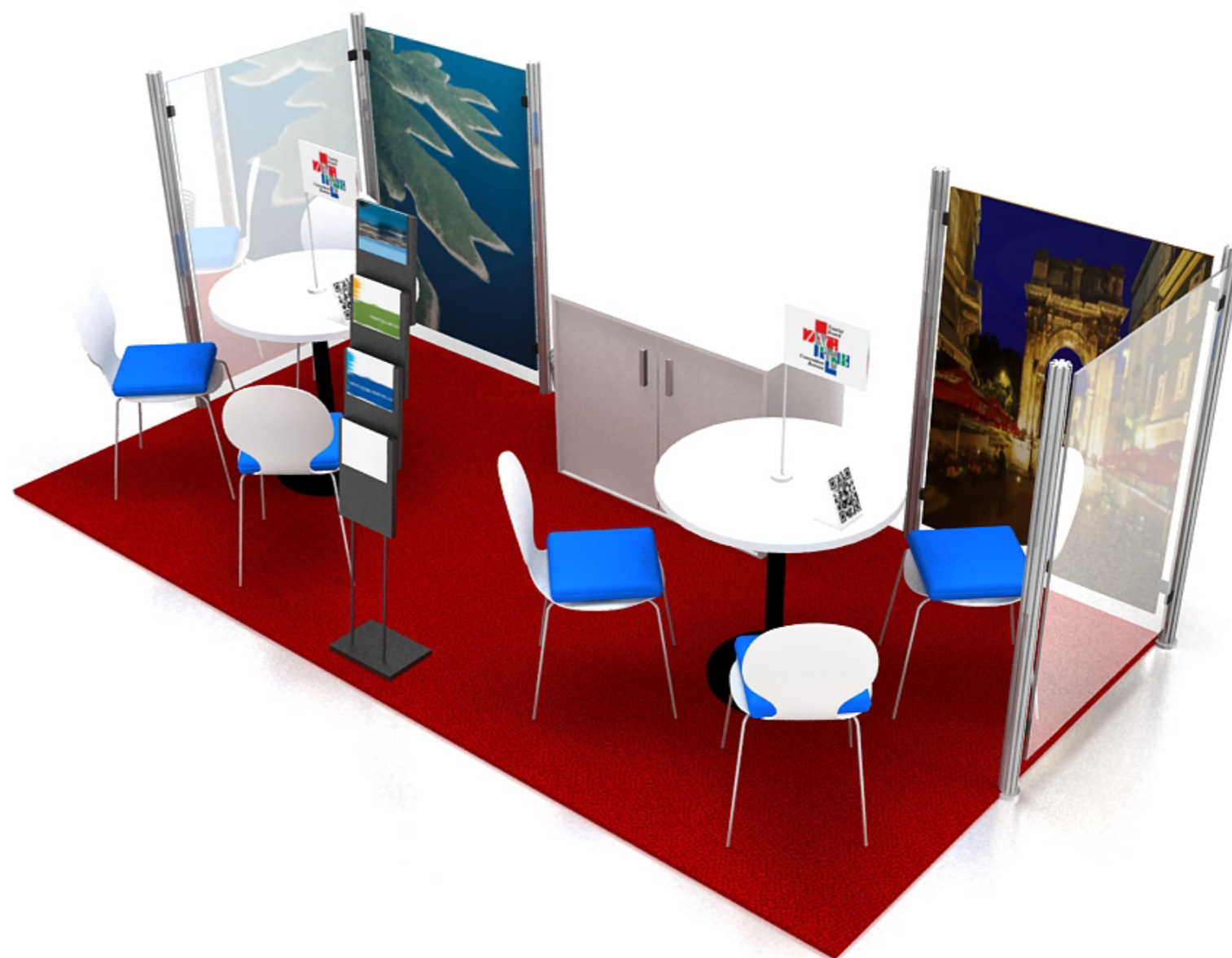
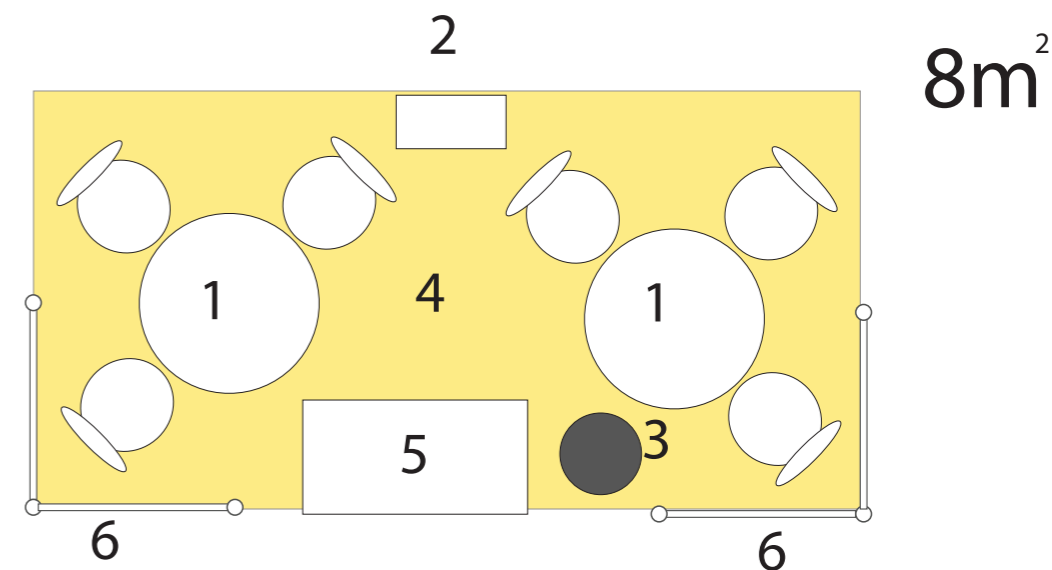

23

Suizlagački prostor 10 m²

1. Stol sa stolcima:
stol o 80cm, bijela okrugla ploča
stolac tipa "Flower", bijeli, plavi jastučići
zastavica od foreksa sa logotipom suizlagaca
QR code na stalku od bijelog opal pleksiglasa
2. Barski stolac
3. Koš za smeće
4. certificirani protupožarni tepih crvene boje
5. Info pult od bijelog iverala sa prosvjetljenim pleksiglasom
- 6 Pregradice:
alumijski stupovi sa prozirnim pleksiglasom ili grafikom

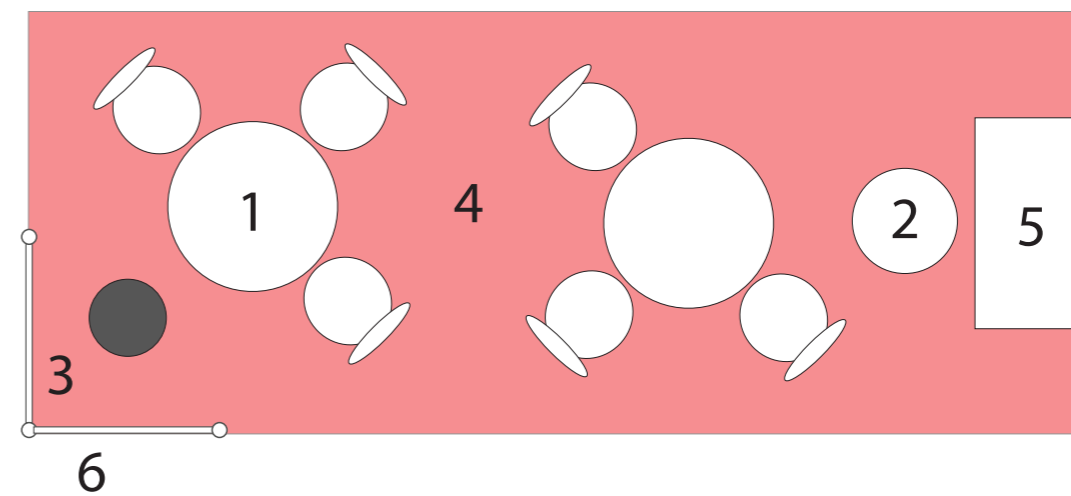

10m²

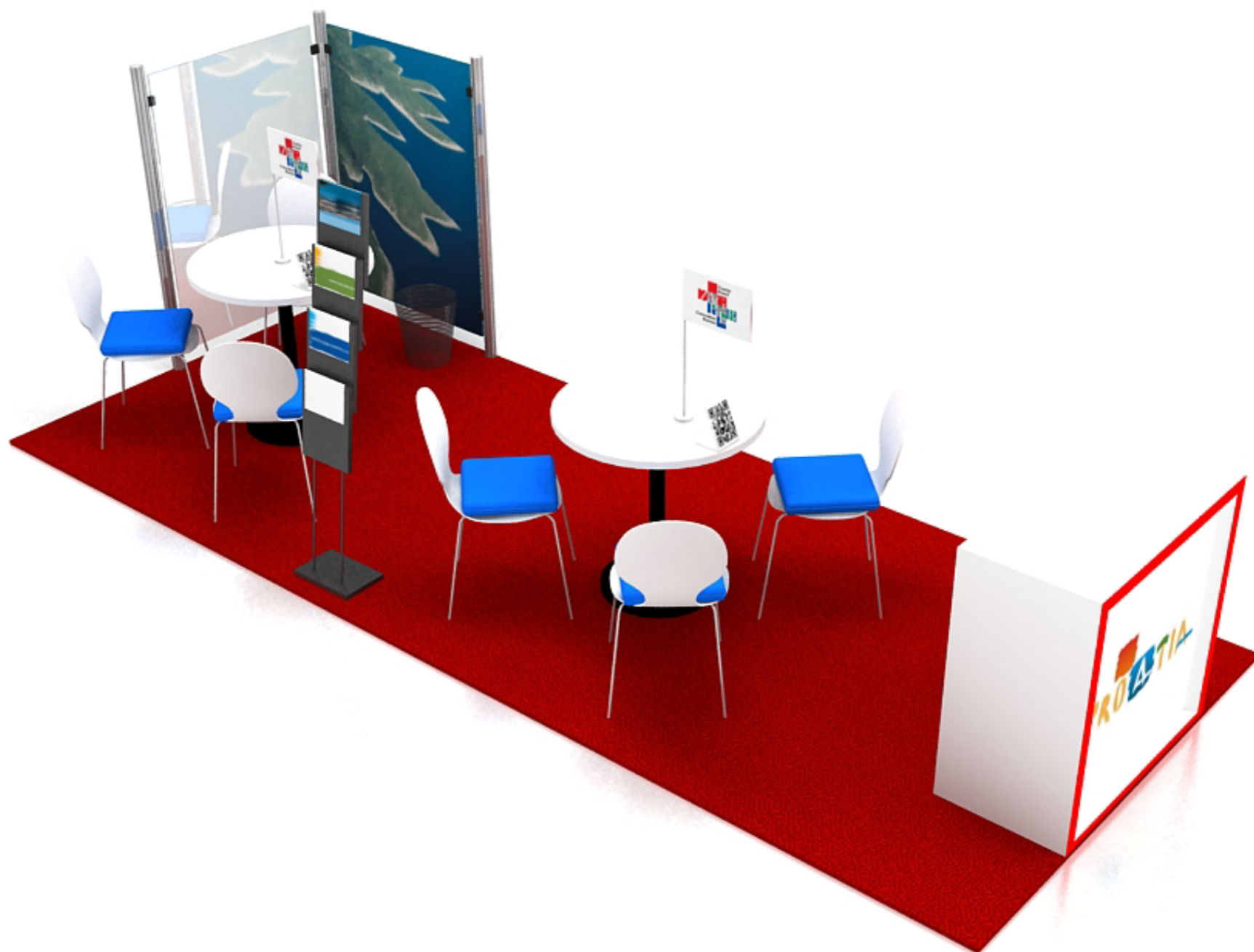

1. Regal police - 3 etažna - 100x50x250cm
2. Radna površina 100x50x100cm
3. Mini kuhinja
4. Hladnjak
5. Koš za smeće
6. Vješalica
7. Plazma na samostojecem stalku
8. Vrata skladišta
9. Elektroormar
10. Stijene skladišta

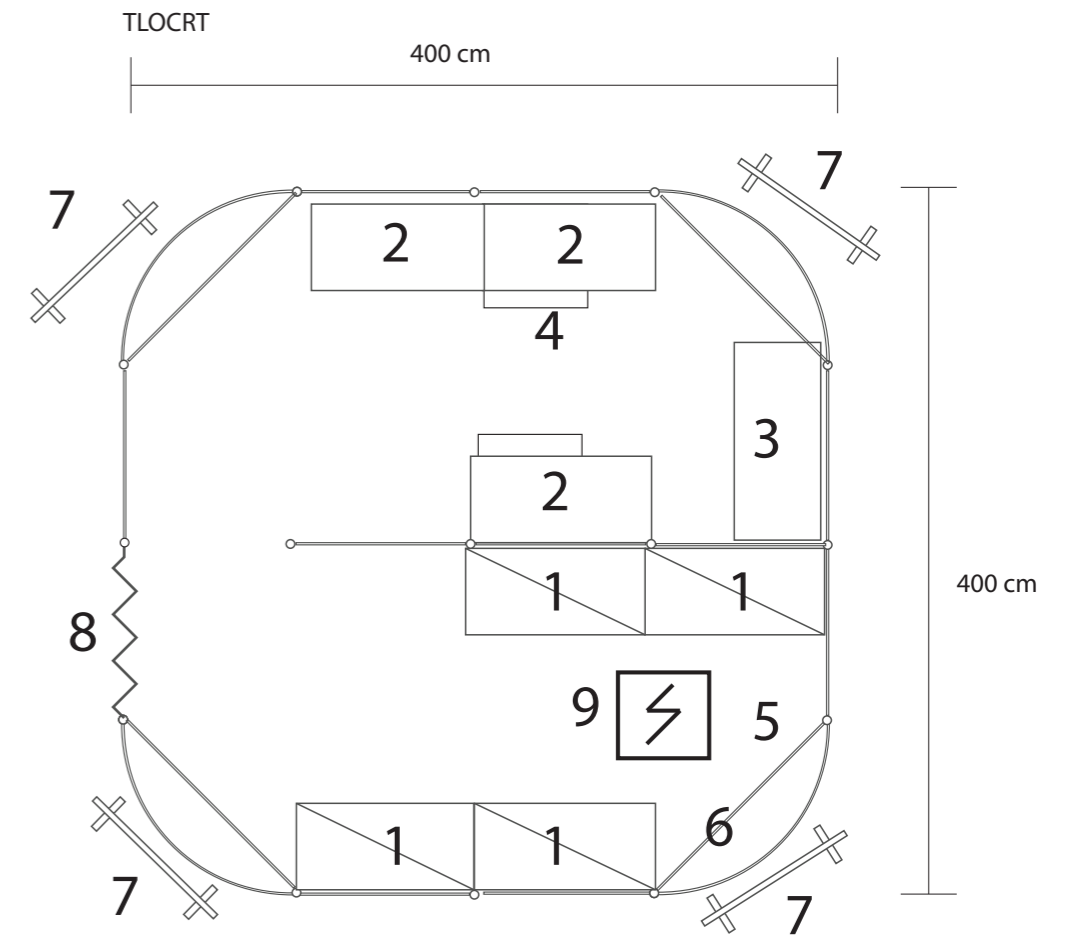

POGLED

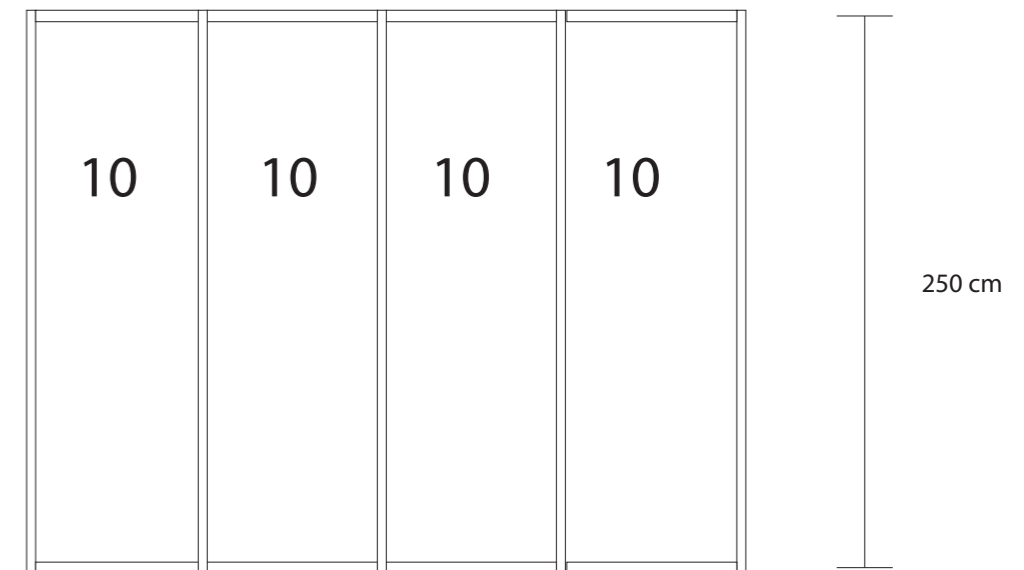

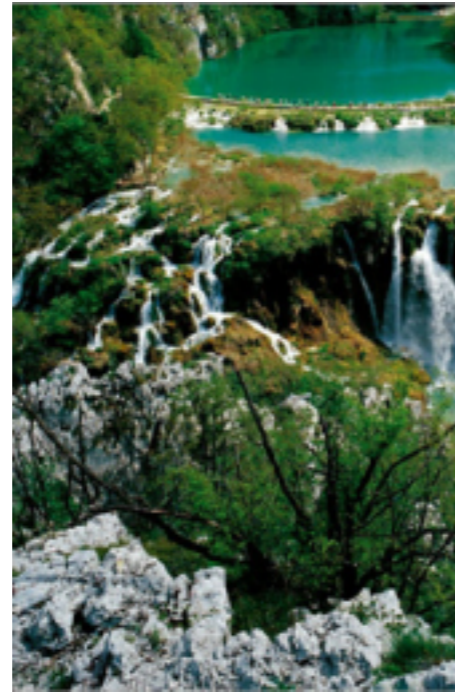

151 cm

235 cm



95 cm

235 cm

1. Aluminijski stup promjera 6 cm, visine 150cm
2. Pleksiglas prozirni ili sa grafikom (pvc naljepnica) 95x145cm

Pleksiglas / grafika

95 cm



145 cm

TLOCRT

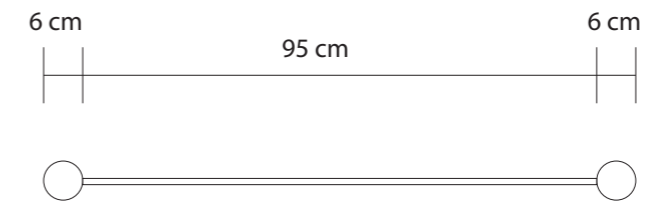

POGLED

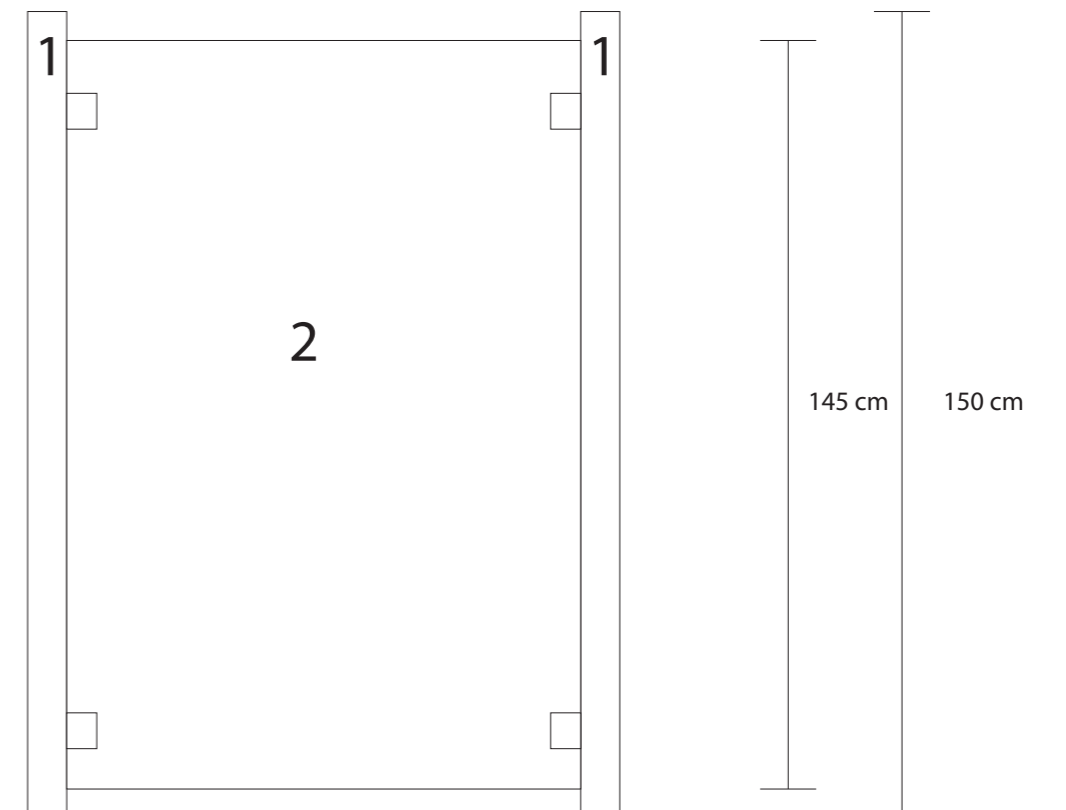

QR code - pleksiglas stalak

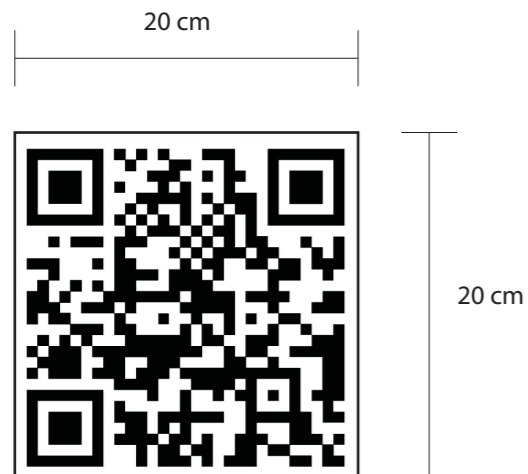

Zastavica - foreks

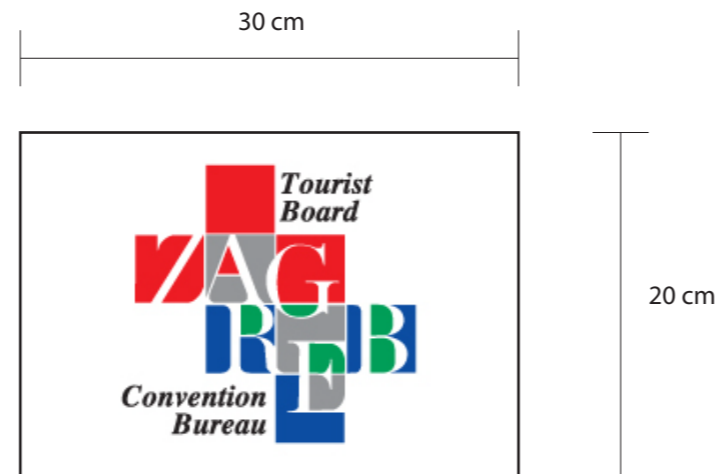

TLOCRT

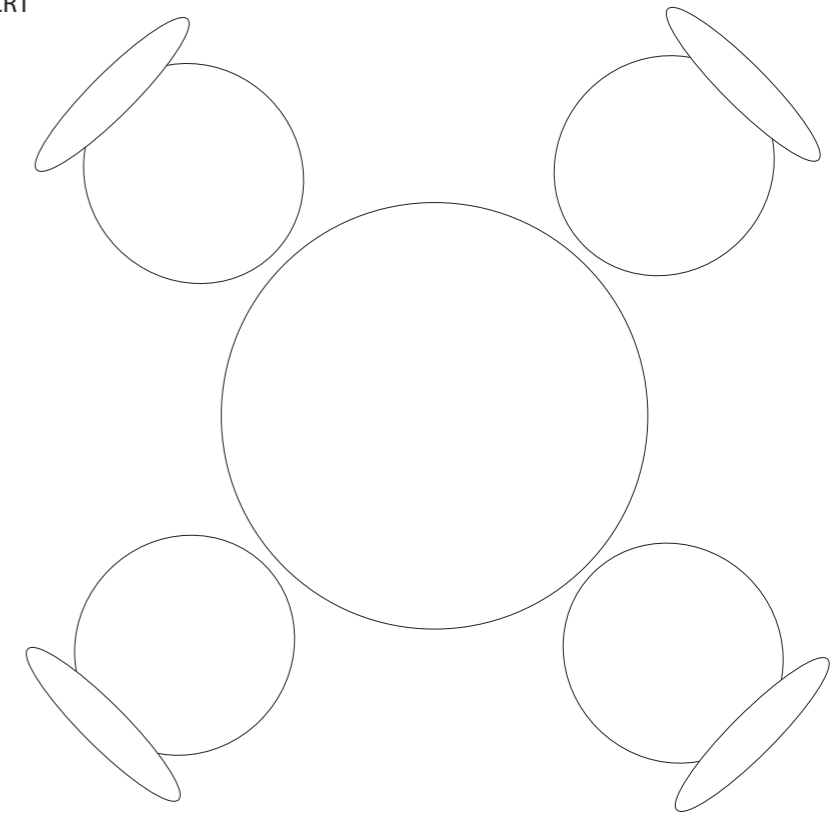

POGLED

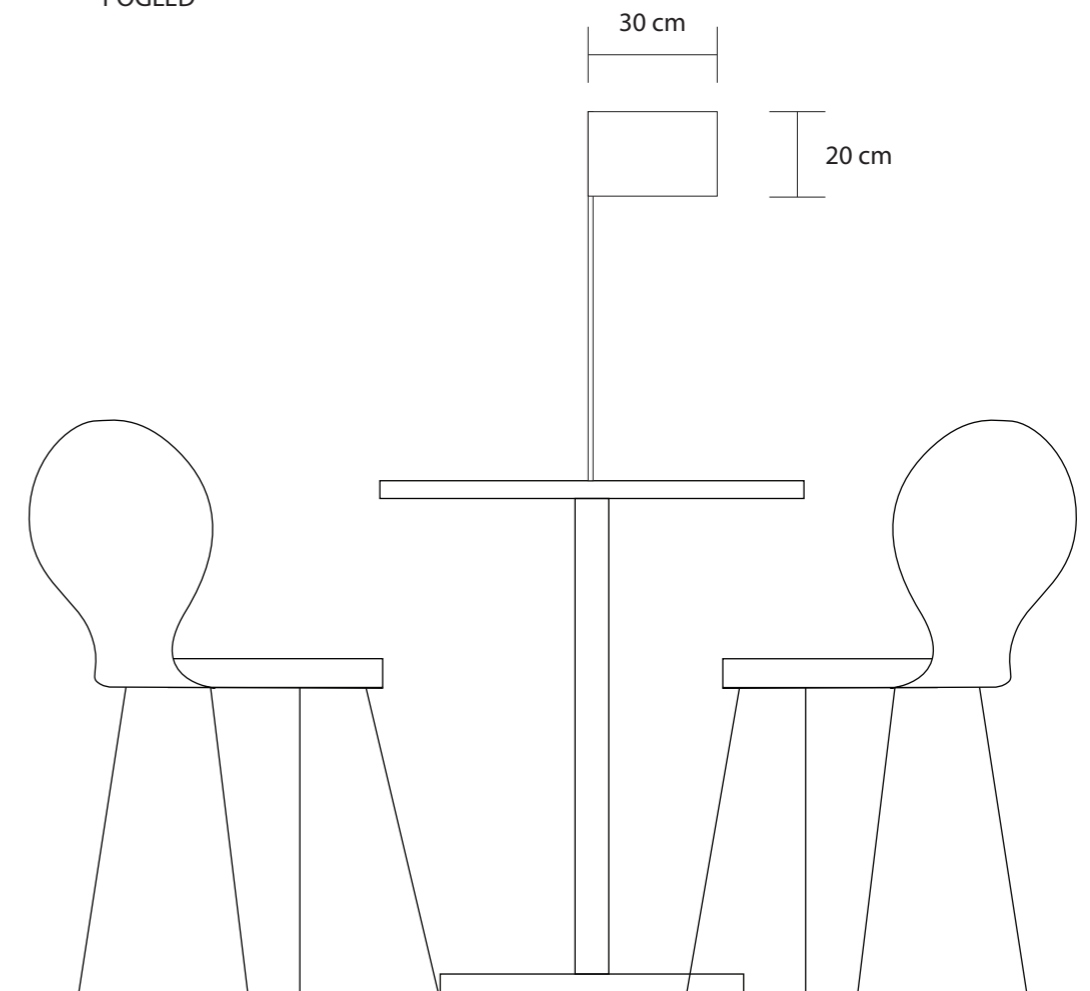

Detalj 5: info pult

3d



Dimenzija loogitpa na pultu



TLOCRT

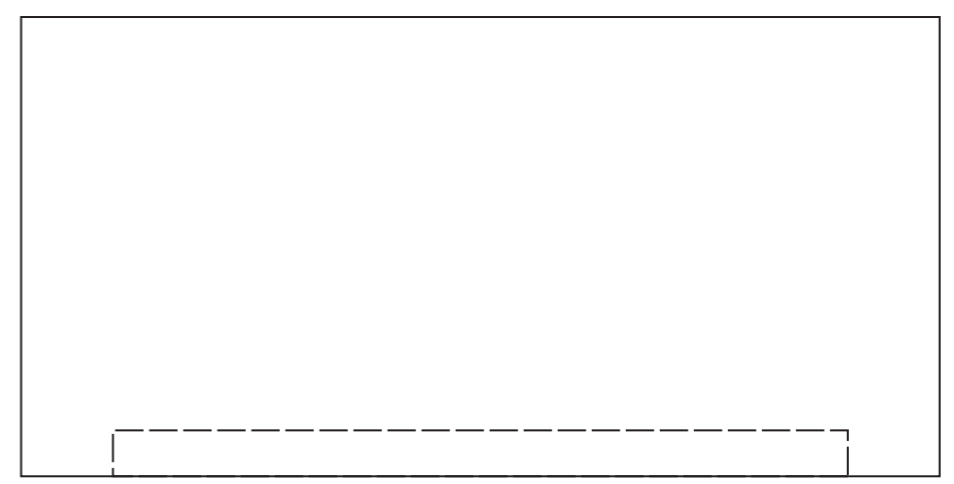
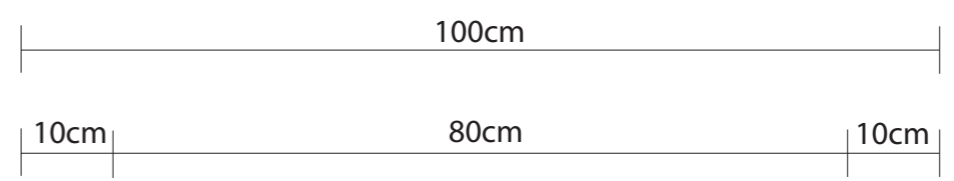

POGLED



45cm

5cm

100cm

80cm

10cm

10cm

Detalj 7: klupa za sjedenje

TLOCRT

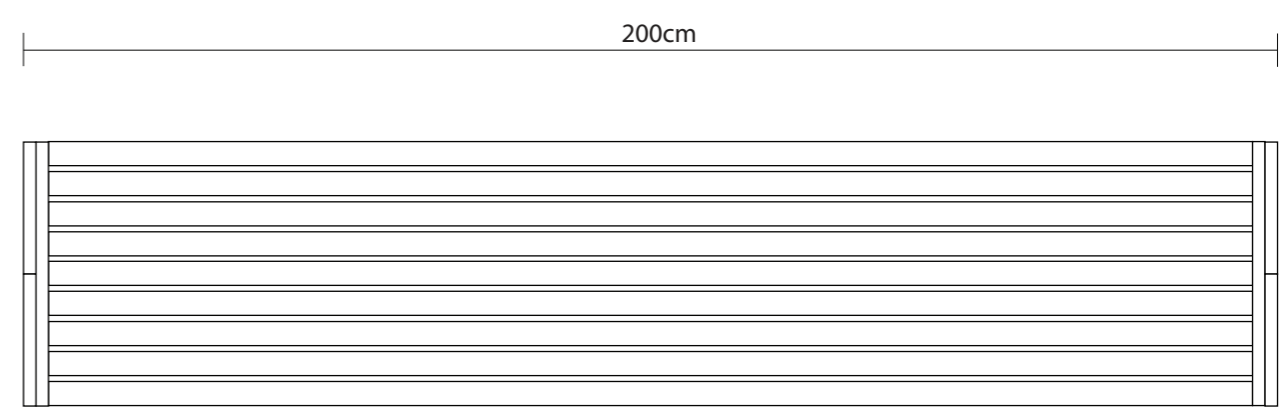

POGLED

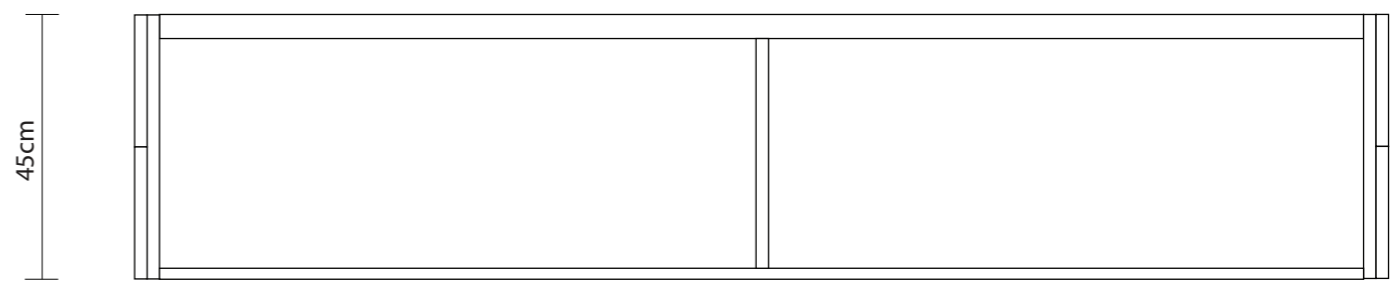

3D

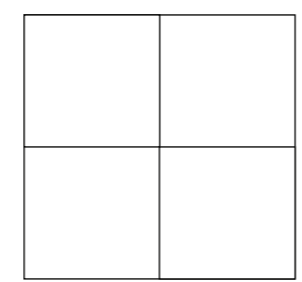
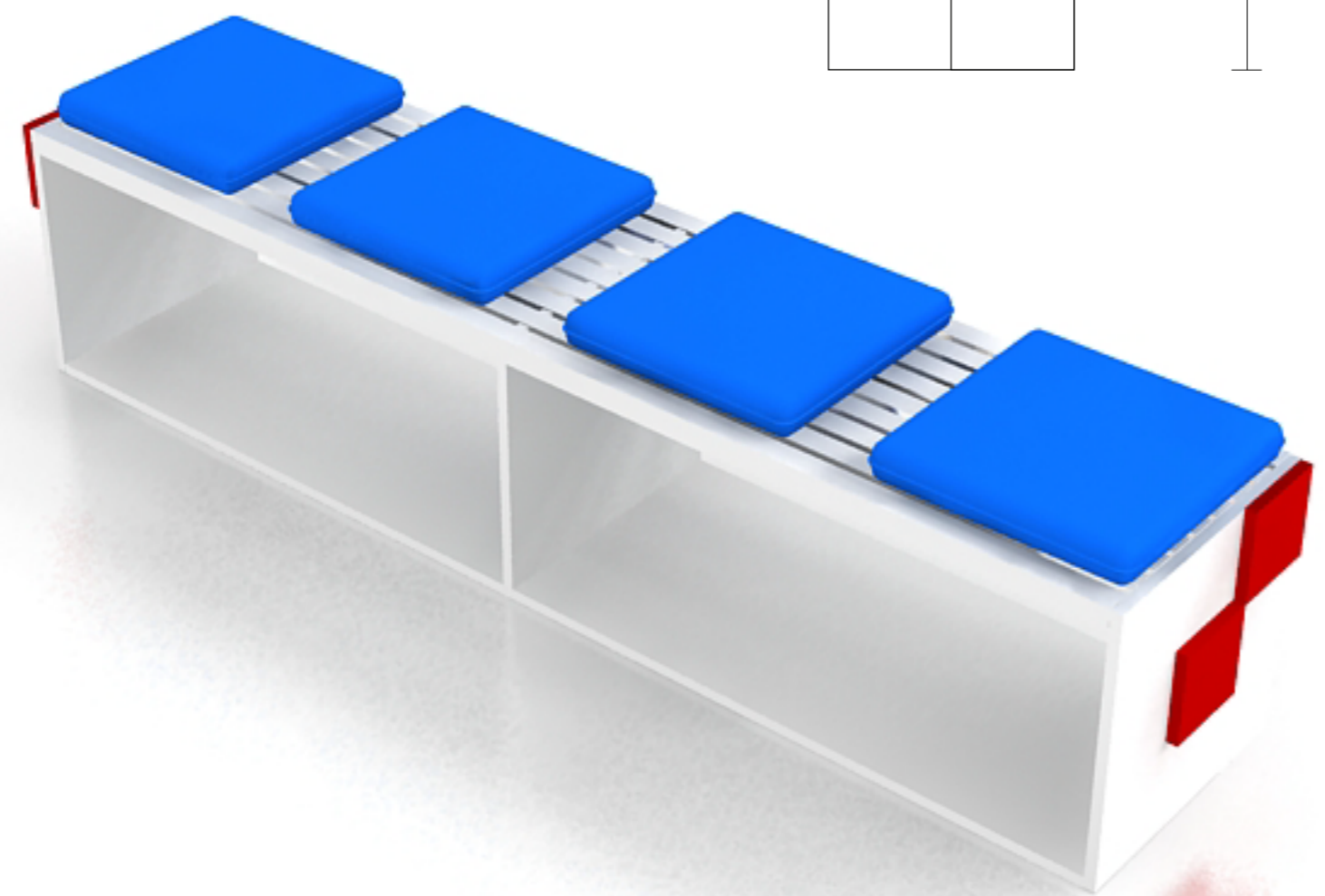

4KH40

Raspon u m	4,00	6,00	8,00	10,00	12,00	14,00	16,00	18,00
Opterećenje u jednoj točki u kg	2078	1372	1014	797	649	541	458	391
Izvijanje u mm	8,00	18,00	32,00	50,00	72,00	99,00	131,00	167,00
Opterećenje u dvije točke u kg	1219	1029	761	597	486	405	343	293
Izvijanje u mm	8,00	23,00	41,00	63,00	91,00	124,00	162,00	204,00
Ravnomjerno opterećenje u kg/m	610	404	254	159	108	77	57	43
Kompletno ravnomjerno opterećenje u kg	2440	2424	2032	1590	1296	1078	912	774
Izvijanje u mm	6,0	20,0	40,0	62,0	89,0	121,0	158,0	200,0

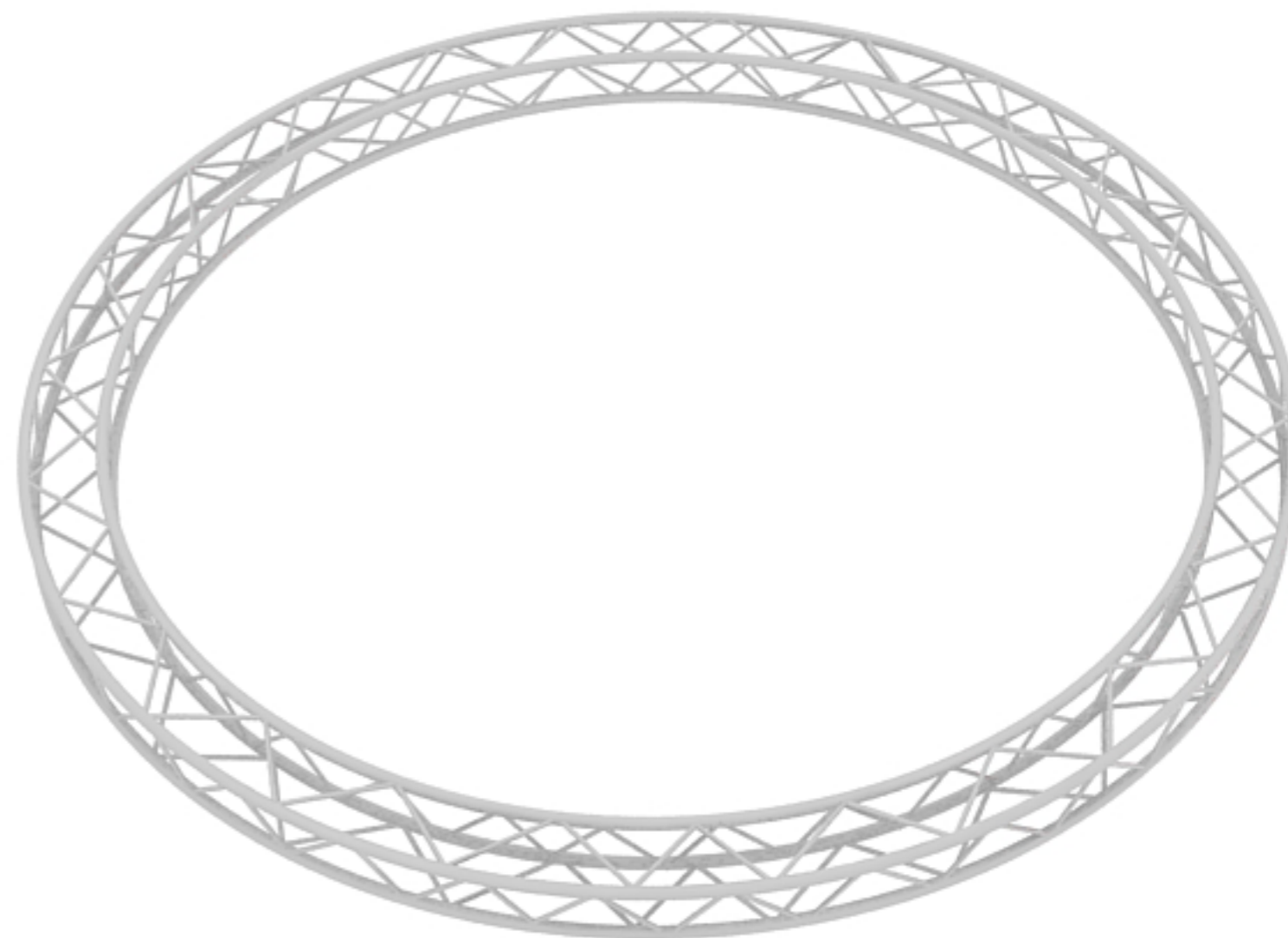

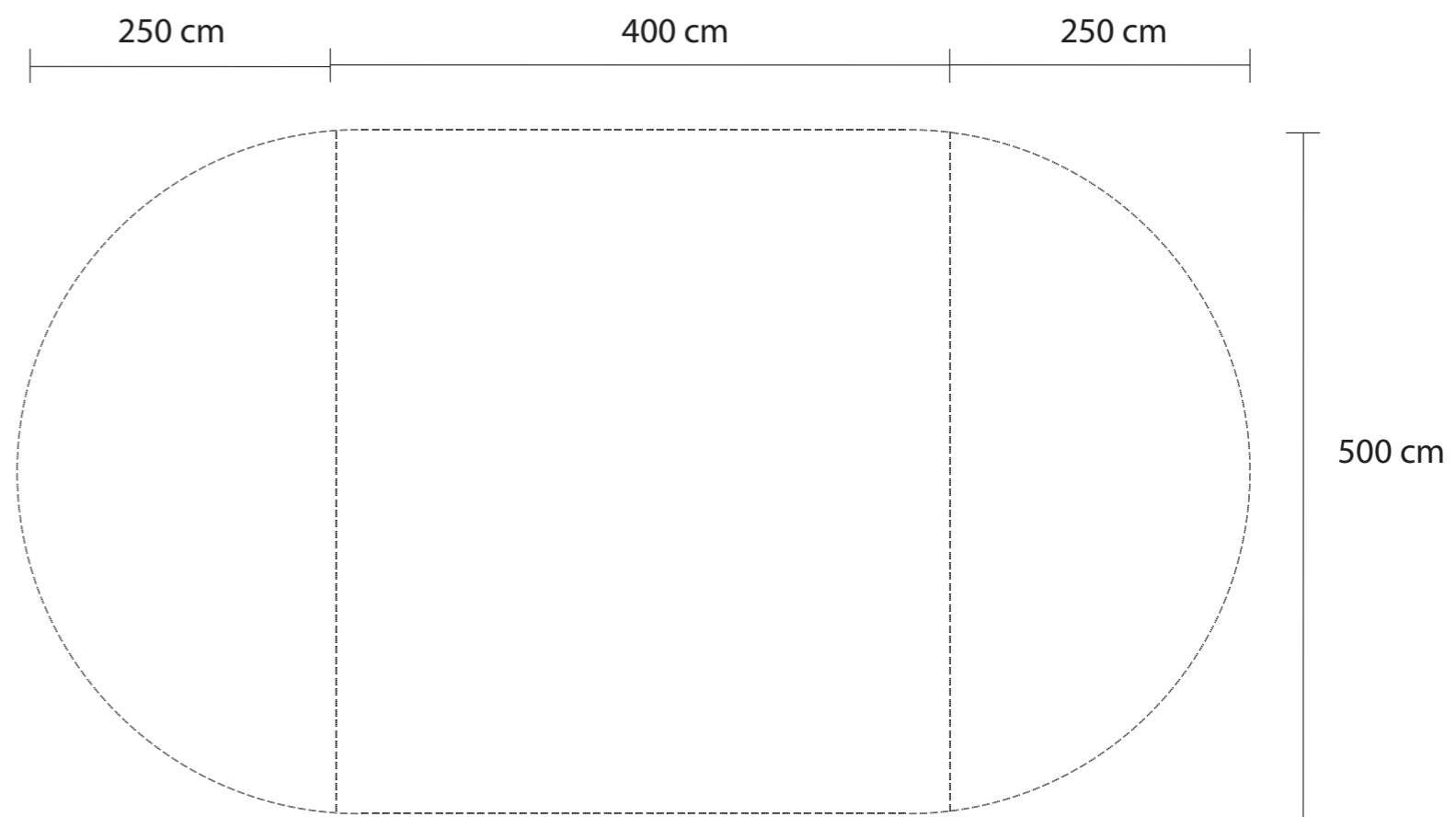
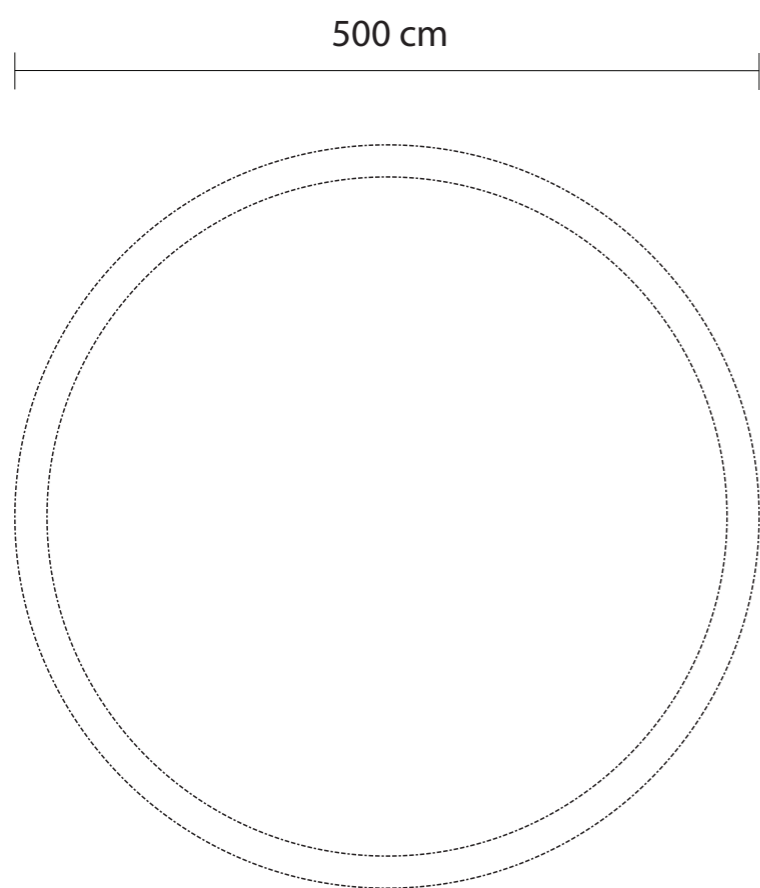

32 Detalj 10: Grafika - konstrukcija za vjesanje

Tisak na ceradu - obostrani



1570 cm



33 Detalj 11: Grafika - konstrukcija za vješanje

Tisak na ceradu - obostrani

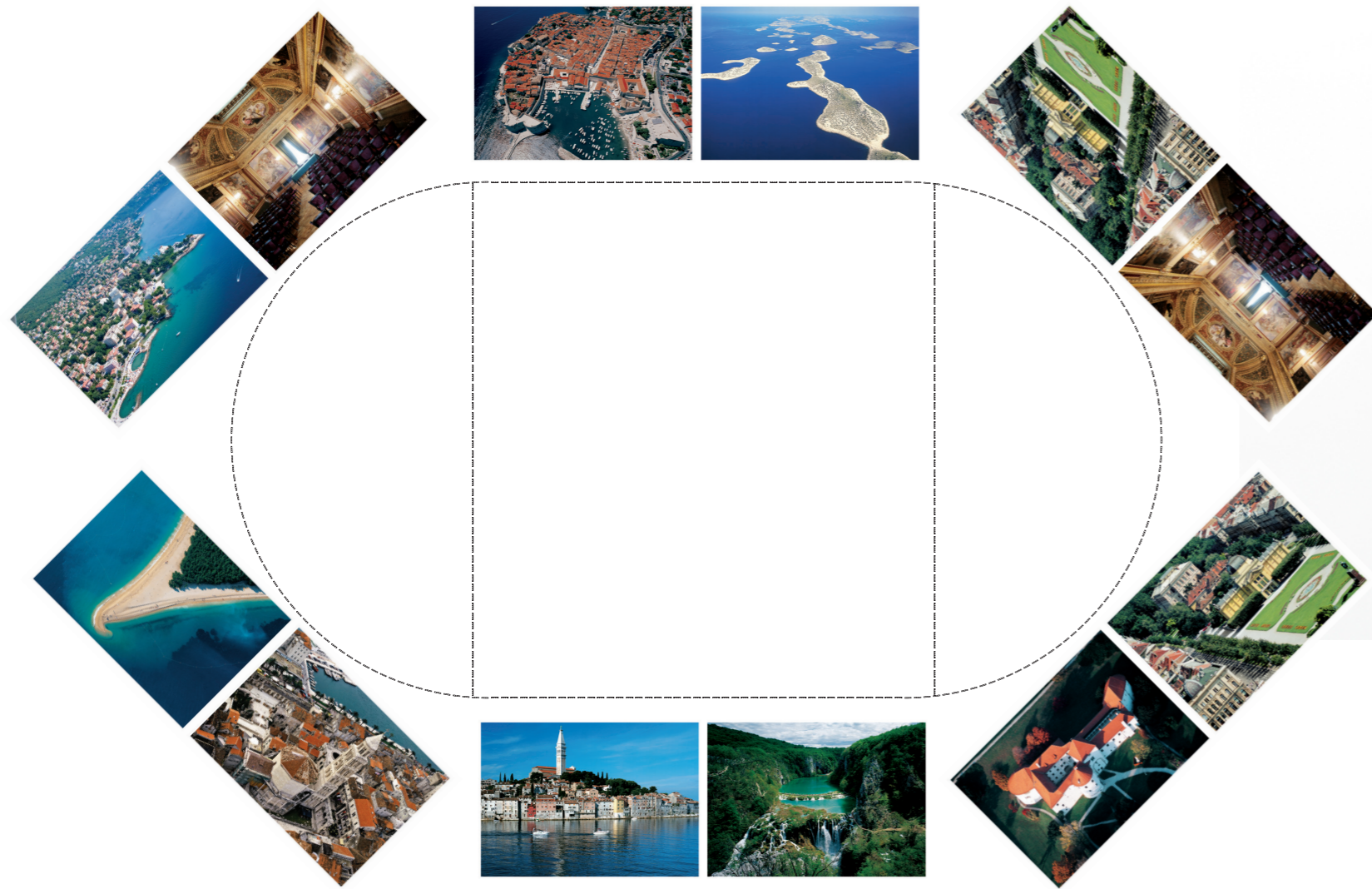

404 cm

397 cm

397 cm

404 cm

397 cm

397 cm



Stolac - nisko sjedenje



Barski stolac



Hladnjak



Radna površina



Barski stol



Stol - nisko sjedenje



Ormarić za suizlagače



Police - troetažne



Mini kuhinja



Plazma 42"
Rezolucija 1280x768px
DVD player



Zidni nosač za plazmu

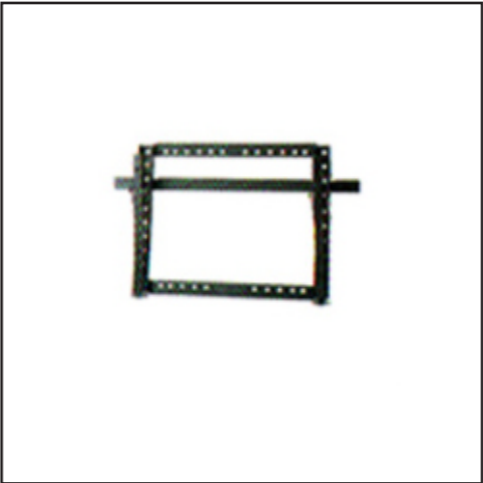

Samostojeci stalak za plazmu



Stalac za prospekte



Reflektor 150W Metalhalogeni

